









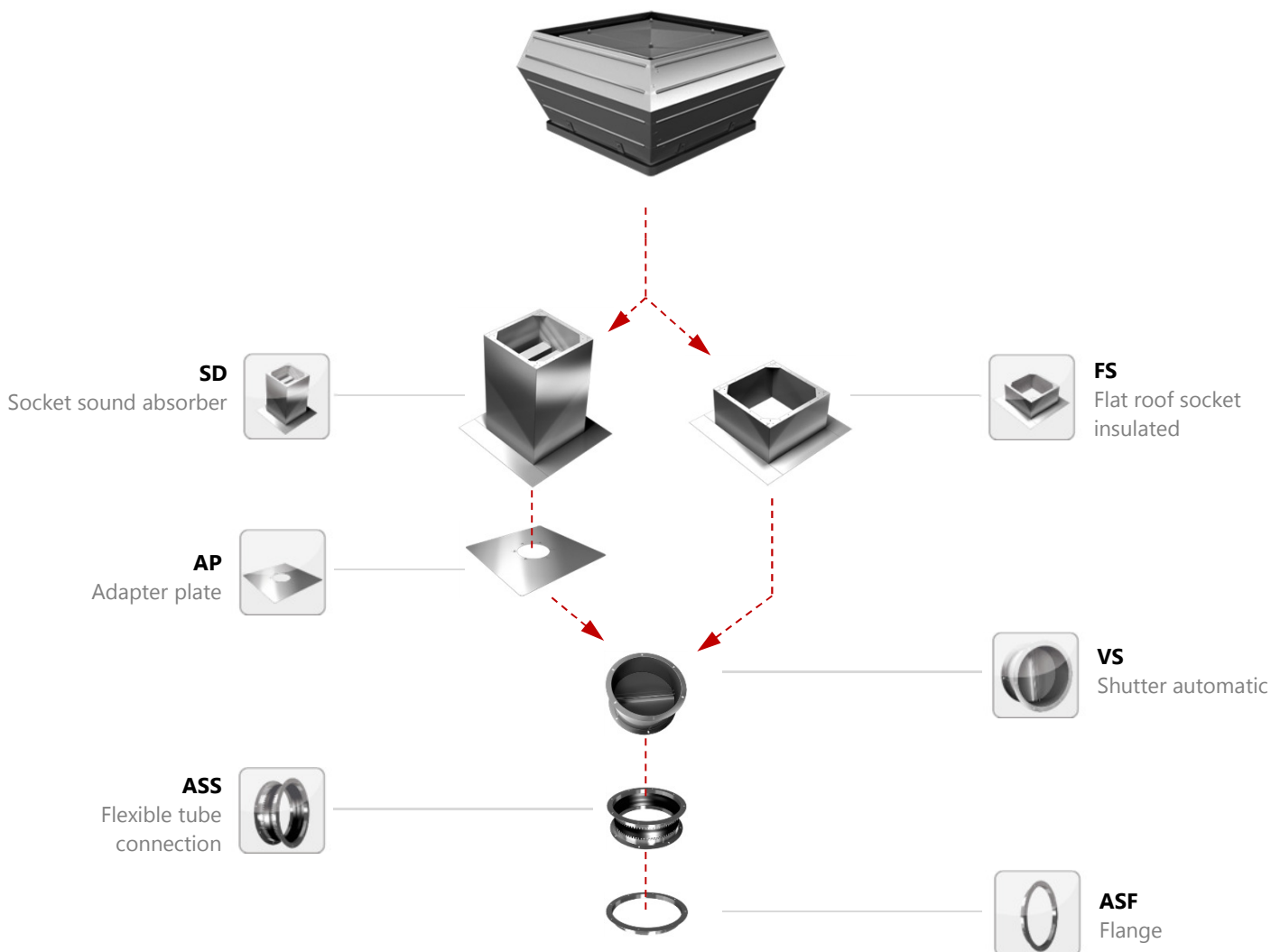

Construction scheme:



DV(S)...G / DVW(S)...G
 EC Roof fan
 vertical outlet



Another possible accessories:

- | | | | |
|--------------------------------------------------------------------------------------------------------------------------------------------|------------------------------------------------------------------------------------------------------------------------|-------------------------------------------------------------------------------------------------------------------------|------------------------------------------------------------------------------------------------------------------------------------|
| 
VM
Shutter motor driven | 
BG
Protection guard | 
KR
Swing-out frame | 
SDS
Base for sloping roof 1-45° |
| 
SSD
Sound absorber for sloping roof 1-45° | 
POT 1
(Potentiometer) | 
POT 2
(Potentiometer) | |

Installation notes with shutter automatic VS:

Installation in conjunction with Flat roof socket (FS)

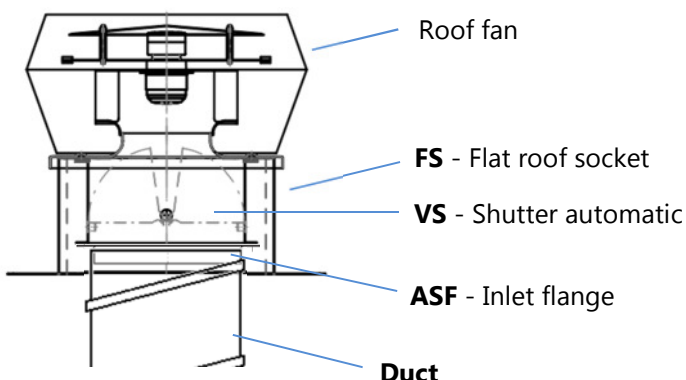

Installation in conjunction with Socket sound absorber (SD)

RIGHT

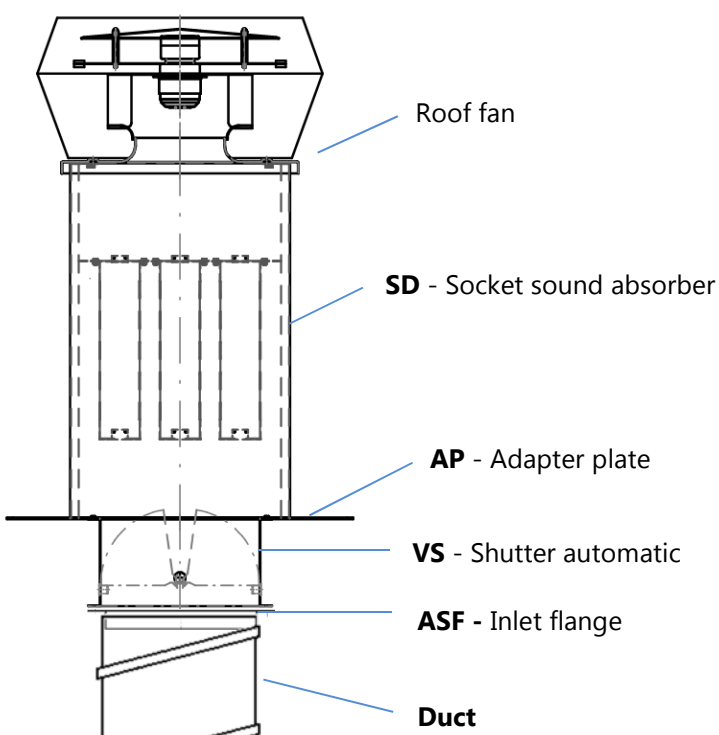

WRONG

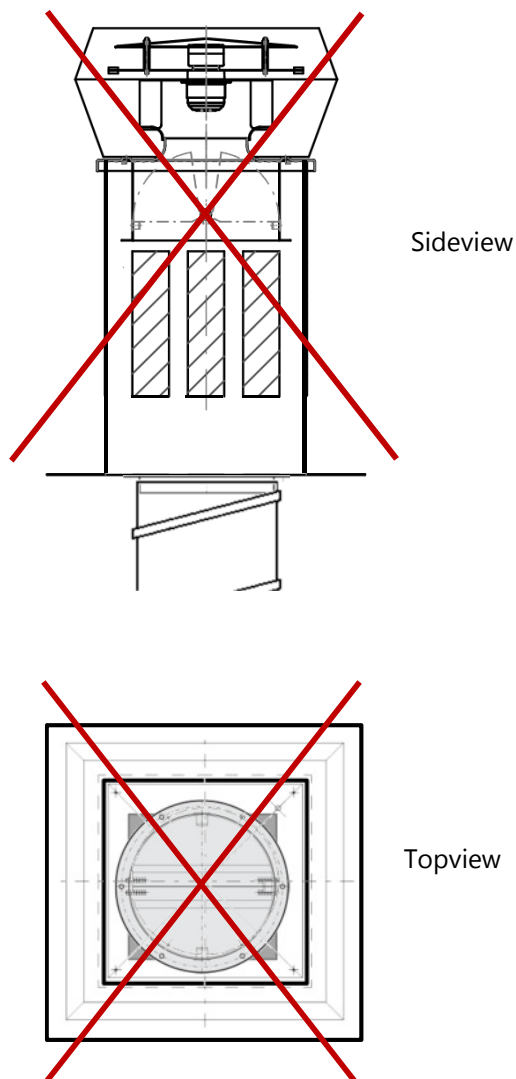

Installation of accessories

Step 1

Installation shutter automatic

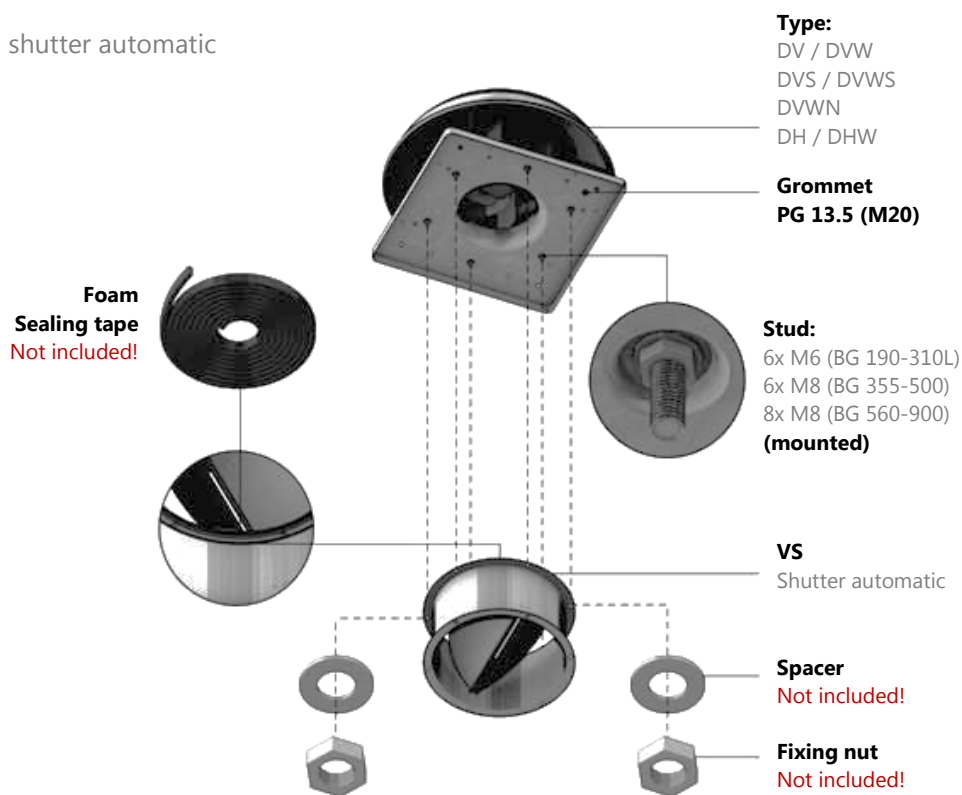

Step 2

Installation flexible tube connection

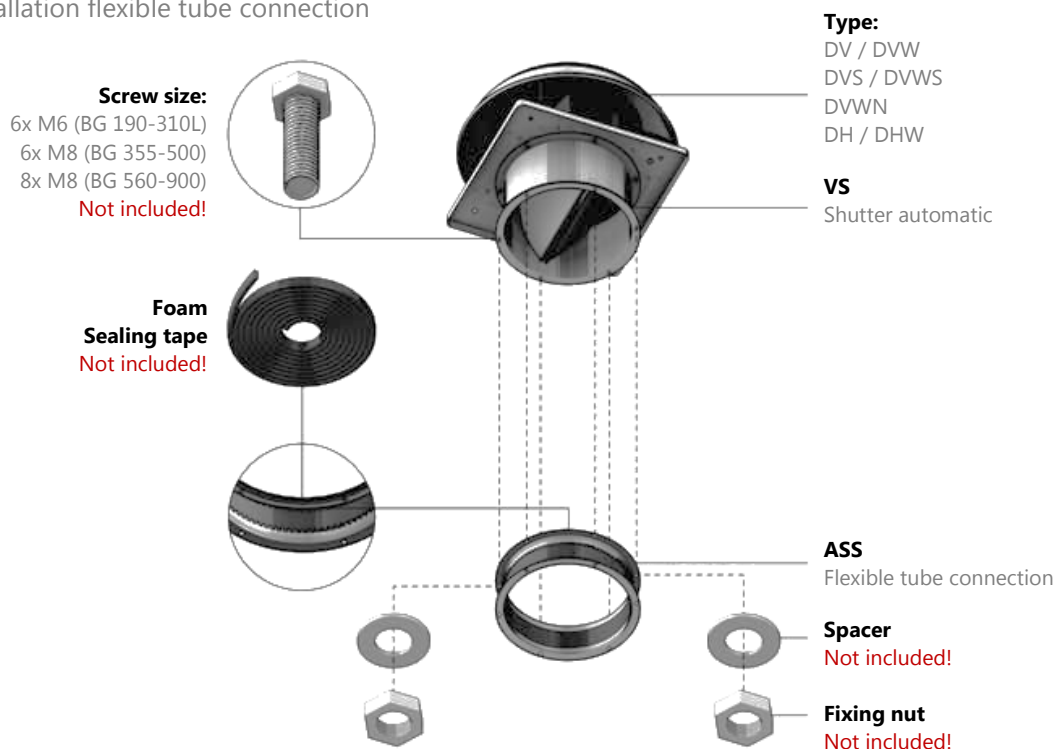

Step 3

Installation flange

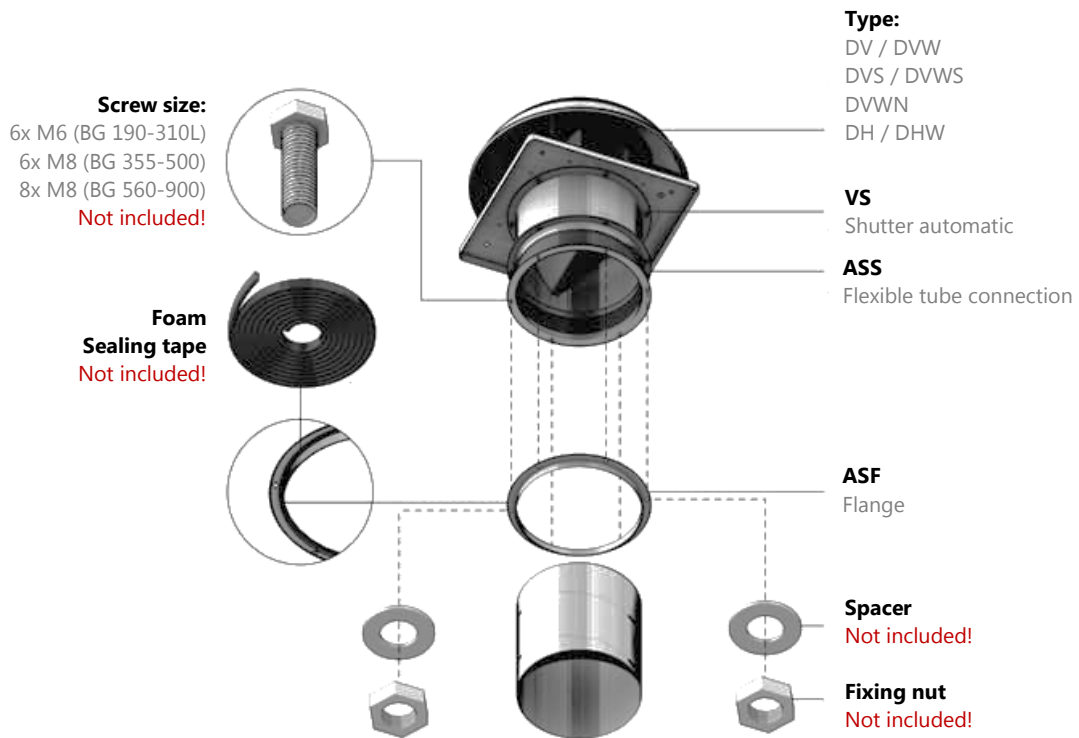

Step 4

Installation Flat roof socket

